

Model Series:

SCS/SCS-LP



**COMMERCIAL
COMPACTOR**

Self-Contained

10 to 39 Cu. Yd.

The SCS/SCS-LP Self-contained series feature an integral compactor, power unit and container — when full, the entire unit is loaded on a roll-off hoist truck for transport to a disposal site

Recommended For:

- ✓ Business Offices
- ✓ Corrugated Material Only
- ✓ Grocery Stores
- ✓ Hotels
- Industrial - Light
- Industrial - Heavy
- ✓ Institutional
- ✓ Recycling Operations
- ✓ Retail Outlets
- Retail Outlets - Large
- Transfer Stations
- ✓ Warehouses



SCS/SCS-LP Series



SCS2235 self contained unit with rear load ground load barn door style hopper with two interlocks.

- **Designed specifically for sanitary handling of wet and liquified waste operations**
- **Integral compactor, power unit and container — when full, the entire unit is loaded on a roll-off hoist truck for transport to disposal site**
- **Standard height 48” compactor or low profile 42” height for hand cart dumping**
- **SCS compactors feature a two cylinder design for medium to large volume applications**
- **The standard model has an 8’ wide octagonal container (6 or 7’ width rectangular containers are optionally available)**

Self-Contained Compactors

Model Design/Performance Overview

Capacity	Cu. Yds. Per Hour Cu. Yds.	10 — 39 95
Cycle Time	(Seconds)	36
Clear Top Opening	L x W (Inches)	40 x 56.5
Hydraulic Cylinders	(Qty) Bore x Rod x Stroke (Inches)	(2) 4 x 2.5 x 34
Ram	Penetration (Inches) Face Dimensions W x H (Inches)	5.5 59.5 x 30
Packing Force (lbs)	Normal Maximum	37,700 45,238
Operating Pressure (PSI)	Normal Maximum	1500 1800

Construction Specifications

Frame

Floor:	3/8" A36 Steel
Structural Channel:	C2" x 2.32#
Sides:	1/4" A36 Steel
Side Supports:	C4" x 5.4#
Breaker Bar:	L6" x 6" x 3/4"
Ram Hold Down Bars:	1" x 1-1/2" Bar

Ram

Face Plate:	1/2" A36 Steel
Floor Plate:	1/2" A36 Steel
Side Plates:	1/4" A36 Steel
Top Plate:	1/4" A36 Steel
Top Supports:	C4" x 5.4# Structural Steel Channels
Guides:	Adjustable Nyloil Blocks

Power Unit

	24" W x 45" L x 33" H
Oil Reservoir:	25 Gal.
Oil Pump:	10 GPM, Continuous Displacement Vane
Motor:	10 HP - 208/230/460V 3-PH

Standard Paint Finish

SP Industries offers a variety of standard paint color at no charge.

Please contact the factory for custom color options.



Yellow



Red



Beige



Medium Green

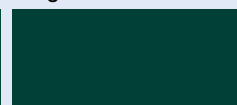

Dark Green



Medium Brown

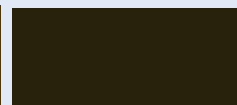

Dark Brown

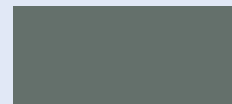

Medium Gray

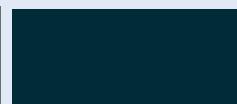

Dark Gray

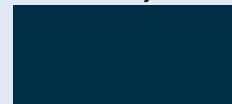

Medium Blue

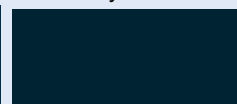

Dark Blue



SCS/SCS-LP Series

Power Unit Features:

- Remote Power Unit
- 10' Hydraulic Hoses w/ Quick Disconnect Fittings
- 10' Power Supply Cable
- Tri-Volt 3 Phase Motor (208V, 230V, 460V)
- Soft Shift Pressure Switching Hydraulic System
- Hydraulic Vane Pump
- Hydraulic Reservoir w/ Oil
- Oil Sight Gauge & Thermometer
- Hose Guards on interior Cylinder Hoses

Control Features:

- Controls Mounted in Main Panel
- Key Lock Start Switch
- Automatic Safety Retract on Start
- Ram Shutdown Position Switch
- Mushroom Type Maintained Emergency Stop Button
- Color Coded Oil Pressure Gauge,
- Multi Cycle Timer
- Safety Shut-off Timer

Machine Features:

- Removable Access Panel on Compactor
- Adjustable Nyloil Ram Guides
- Oil Catch Pans under Disconnects
- Octagonal Style Container
- Adjustable Door Hinge System
- Full Door Seal
- Single Side Ratchet Binder Door Latch w/ Safety Chain
- Double End Pickup for Standard ANSI Type "U" Under Structure
- Door End Pickup is Frame Pull w/ Ramp
- Inspection / Fire Ports

Built Tough. Built Better. Built to your Needs.

Working from our extensive range of compactor designs, standard and optional features, and custom engineered solutions, each compactor we build is seamlessly tailored to meet the customer's exact requirements. We are confident that SP Industries compactors offer the best overall cost and performance solution for heavy-duty, long-life compaction and waste handling.

- 30 years engineering and manufacturing expertise
- Local availability through nationwide network of factory-trained dealers and distributors
- Nationwide installation and service
- Best-in-industry warranty program

Please contact us to discuss the best solution for your specific installation requirements



Above: Side loading industrial unit with ground level loading for transfer station application

Left: Industrial unit with extended snout for added container penetration



Self-Contained Compactors

Dimensions

Inches

SCS Standard Size

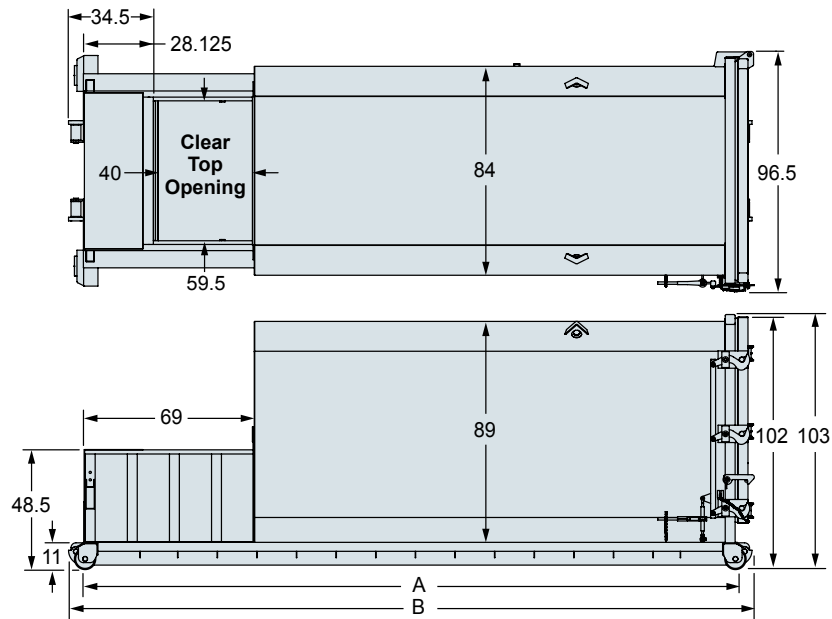
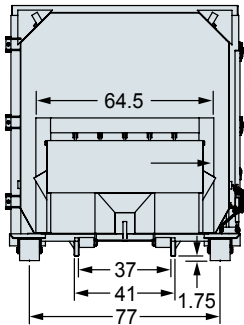

SCS-LP Low Profile Size

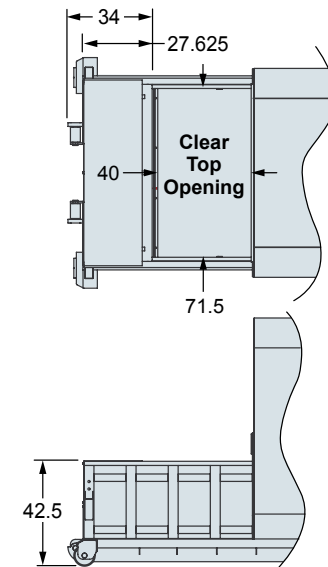
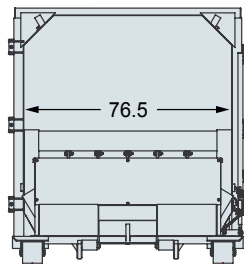

*Dimensions are for reference only.
For detailed critical tolerance issues, please consult factory.*

Model		Capacity Cu.Yds	Dimensions — ft (in)		Weight (approx – lbs)
Standard	Low Profile		A	B	
SCS-1010-OC	SCS-1010-LP	10	10 (120)	11 (132)	7,764
SCS-1113-OC	SCS-1113-LP	13	11 (132)	12 (144)	8,042
SCS-1317-OC	SCS-1317-LP	17	13 (156)	14 (168)	8,600
SCS-1419-OC	SCS-1419-LP	19	14 (168)	15 (180)	8,879
SCS-1521-OC	SCS-1521-LP	21	15 (180)	16 (192)	9,172
SCS-1623-OC	SCS-1623-LP	23	16 (192)	17 (204)	9,375
SCS-1827-OC	SCS-1827-LP	27	18 (216)	19 (228)	9,933
SCS-2031-OC	SCS-2031-LP	31	20 (240)	21 (252)	10,491
SCS-2235-OC	SCS-2235-LP	35	22 (264)	23 (276)	11,250
SCS-2439-OC	SCS-2439-LP	39	24 (288)	25 (300)	11,594



SP Industries Products & Service Nationwide

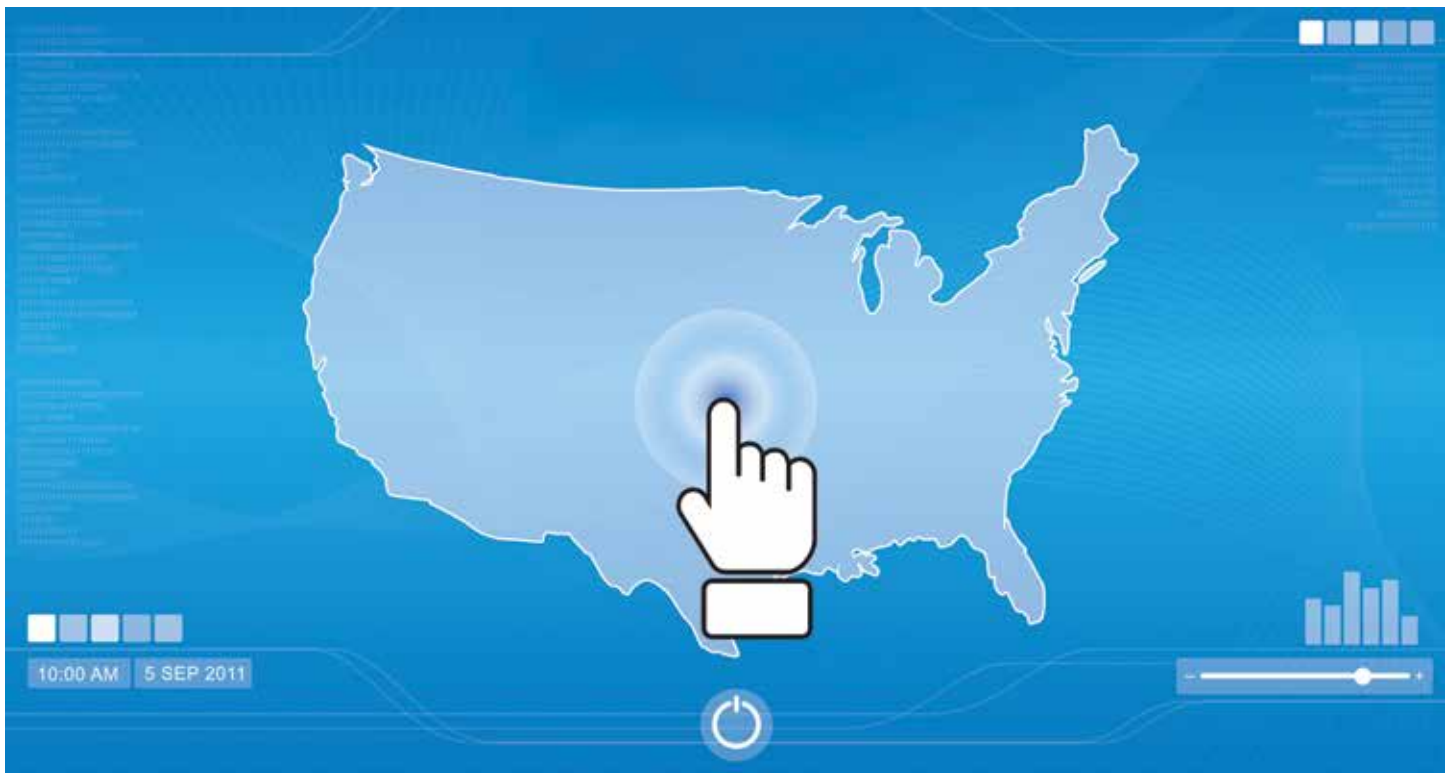

“Let Your [Index] Finger do the Walking”

SP Industries products and services are available nationwide from our sales and service staff and our network of authorized factory-trained dealerships.

For more information or to discuss your specific application requirements, click the map above or call our home office 8am-5pm EST.

Our new EM Series are 100% electromechanical:

- Completely eliminate hydraulic fluid and hoses
- Free up floor space
- Eliminate bulky power units
- Provide safer operation with 24-volt control system
- Eliminate the risk of hydraulic fluid contamination



Designed for environmentally conscious institutional, commercial, and industrial work environments, EM Series units require less maintenance, and remove the potential for fires, leaking seals, and other hazards associated with hydraulic systems.

We look forward to helping you with all your waste removal, material handling, process recovery and recycling efforts.



SP Industries designs and manufactures a comprehensive standard line of industrial and commercial grade compactors with precrushers, transfer station equipment and cart dumpers to meet small to large capacity operations.

We also offer a wide variety of specialized systems to handle wet waste, food products, metal scrap collection, fluid recovery, newsprint recycling and other difficult and/or voluminous materials.



2982 22nd Street Hopkins, MI 49328

www.bestcompactors.com

800.592.5959 • 269.793.3232

Email: info@sp-industries.com

Fax: 269.793.7451